

Nombre: \_\_\_\_\_

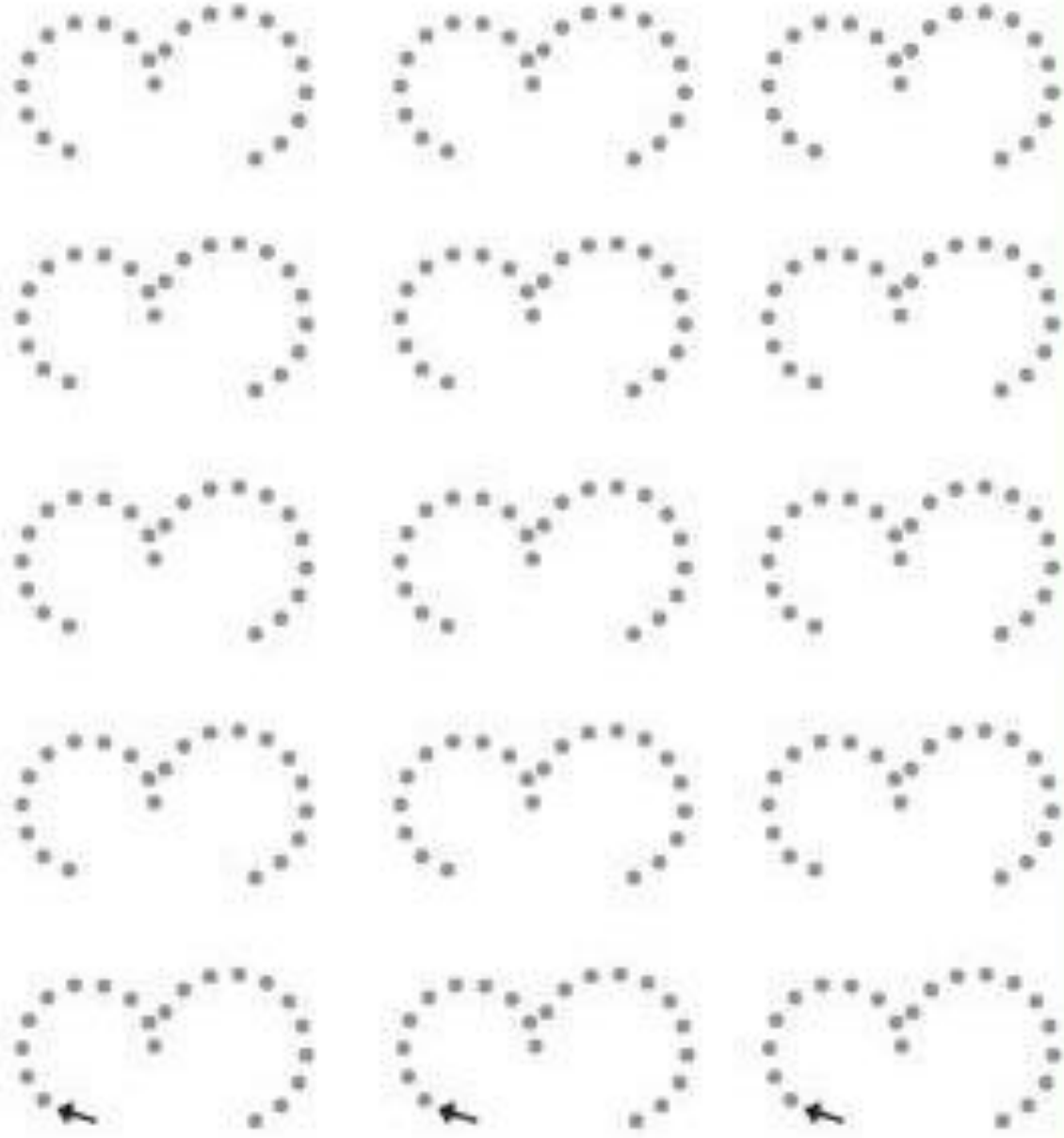

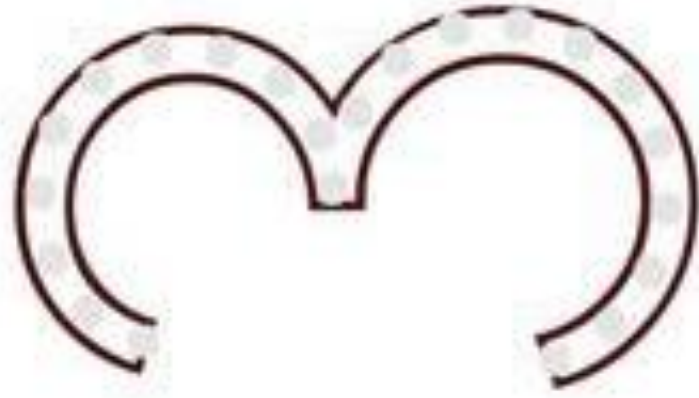

PINTO TANTOS COMO INDICA EL NÚMERO

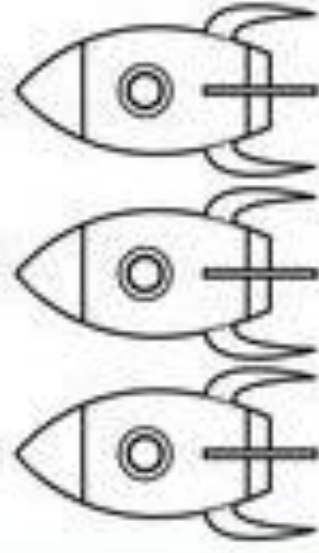
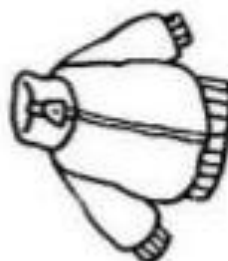
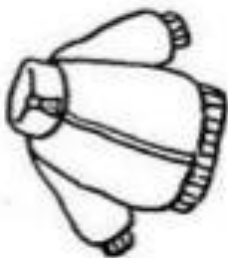

1



2

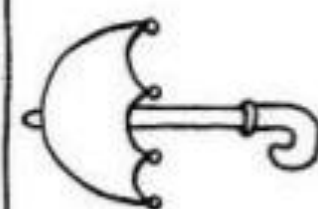
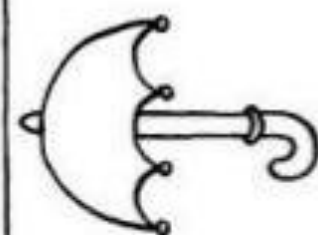
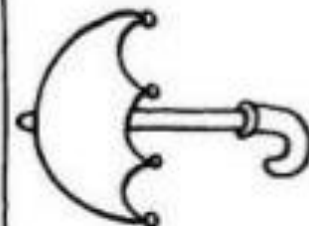
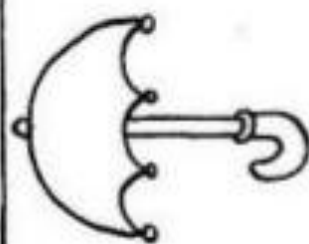

3



COLOREA LOS TOMATES QUE TIENEN EL NÚMERO 3



Colorea del mismo color las formas que sean iguales





LARGO



CORTO

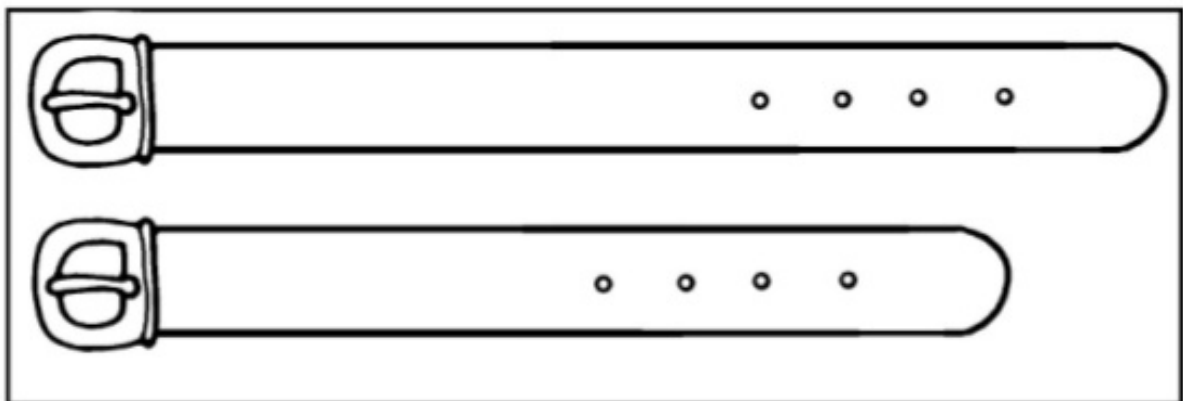
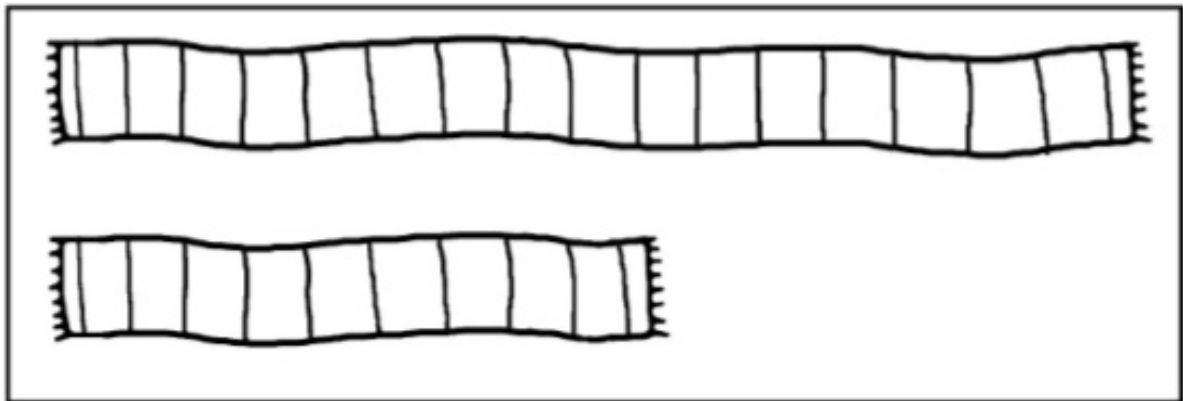
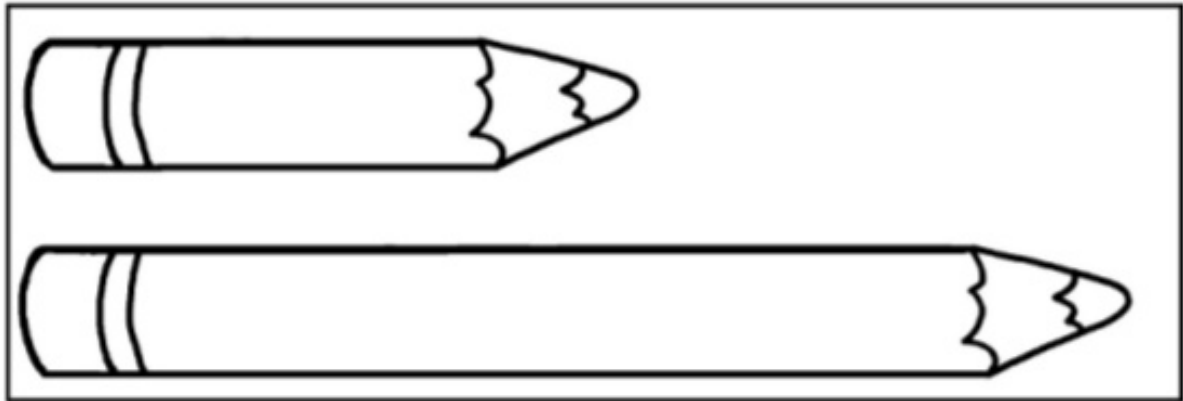

© Santillana Educación, S.L.

NOMBRE: ..... FECHA: .....

→ Colorear el elemento más largo de cada pareja.

**PINTA EL COMPAÑERO DEL MISMO COLOR**

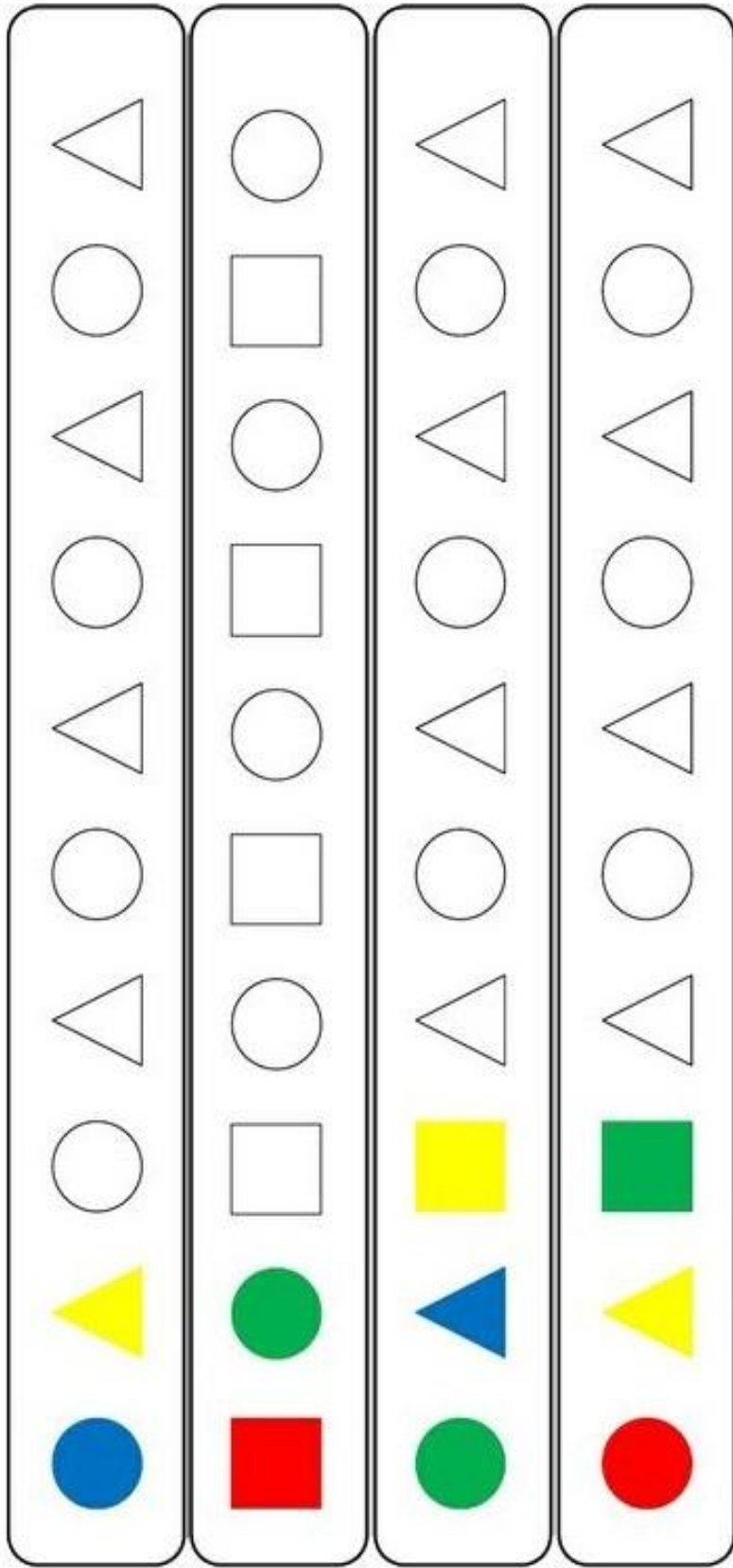

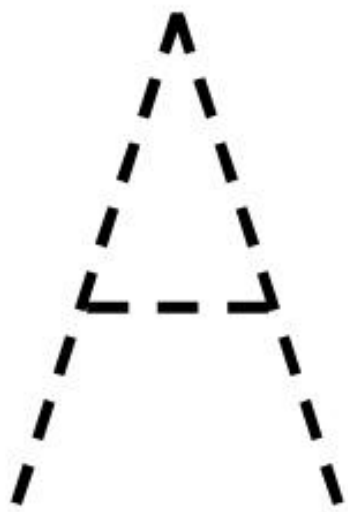

Avión

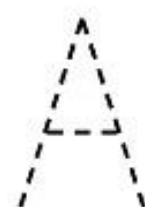
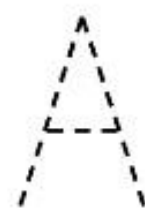
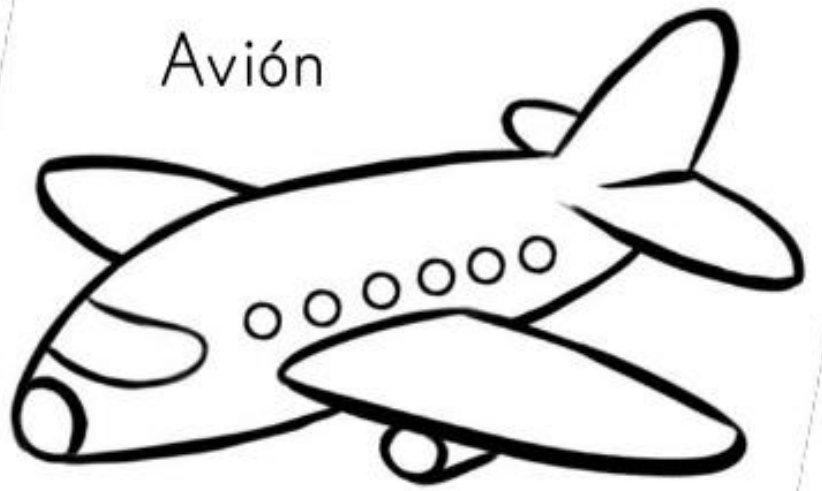

Colorea las vocales iguales

papelisimo.es



BUSCAMOS LA LETRA A



U	A	E	O	U	A	E	O	E
O	U	I	O	O	U	I	O	I
A	I	E	I	A	I	E	I	U
A	A	A	O	A	A	A	O	I
A	U	E	O	A	U	E	O	U



→ \_\_\_\_\_





COLOREA LA PECERA QUE TIENE EL PEZ DENTRO.

Conceptos opuestos: dentro - fuera

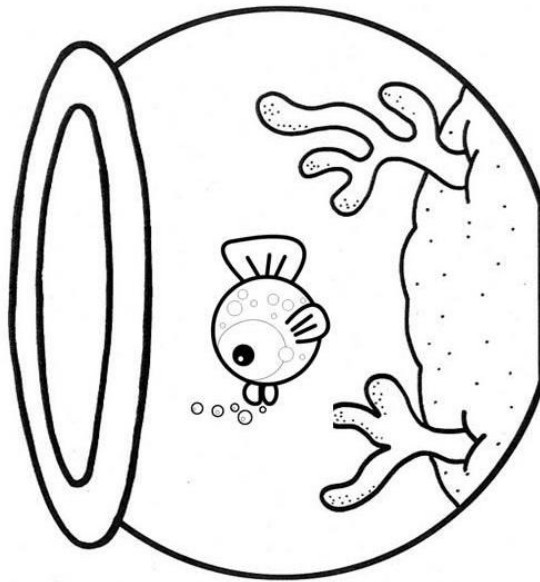

Dentro

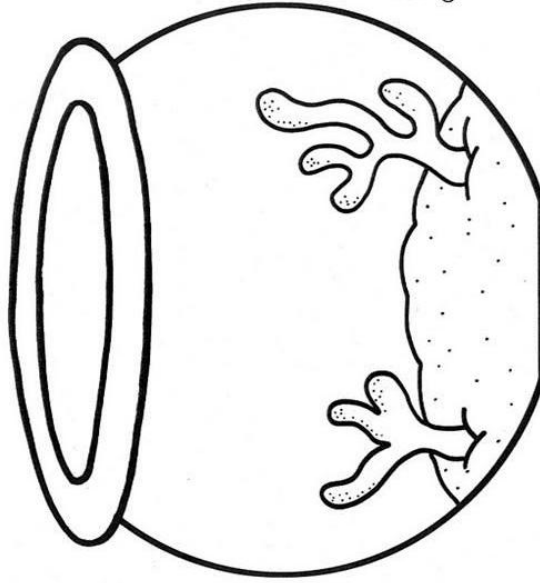

Fuera

Dentro-fuera

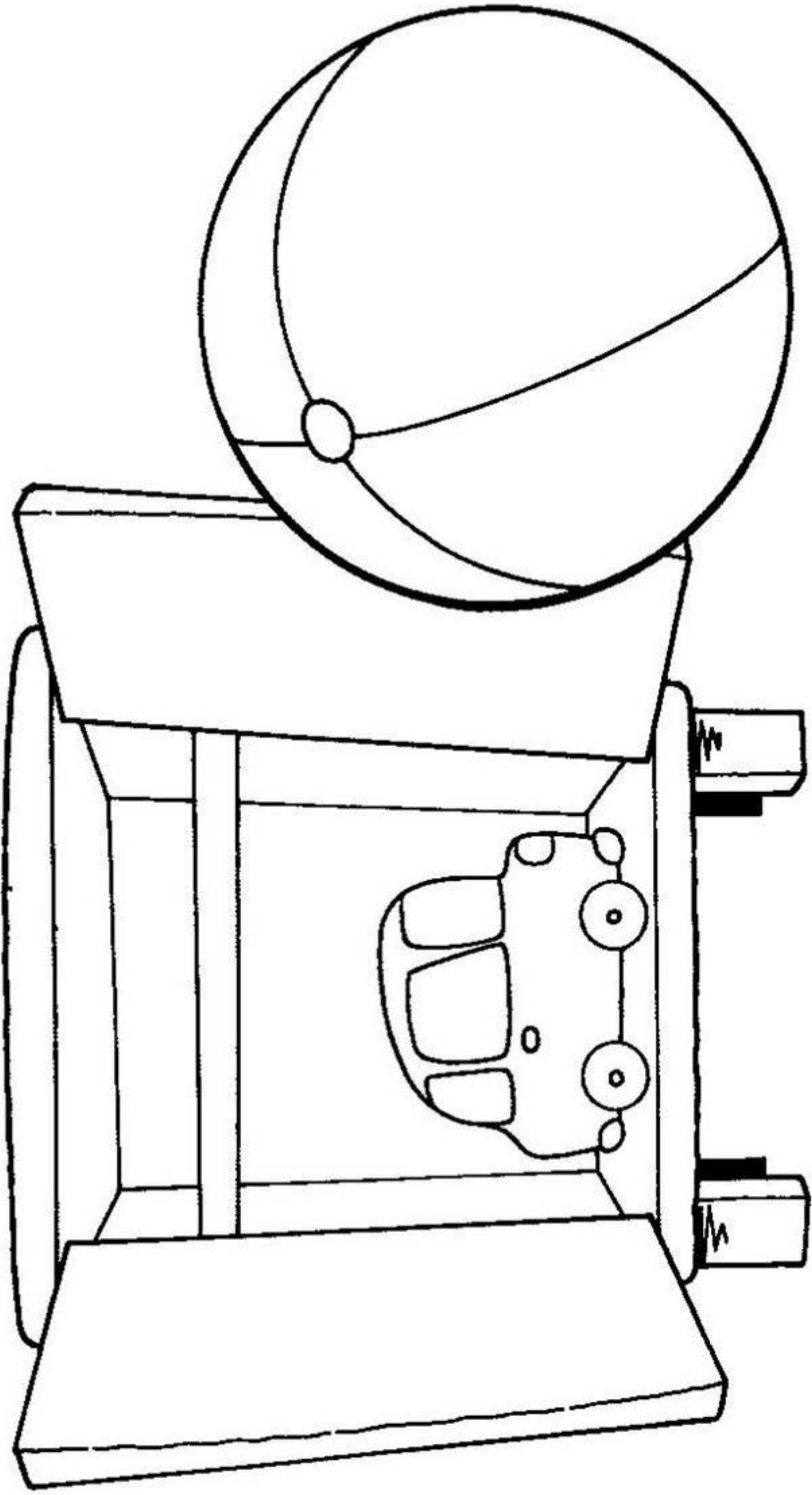

Colorear el juguete que está fuera del armario.

# Arriba-abajo

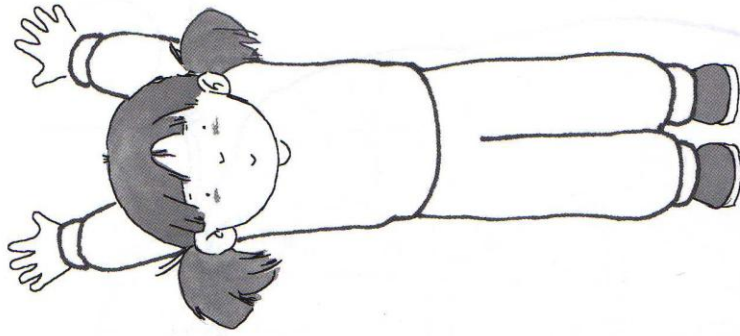
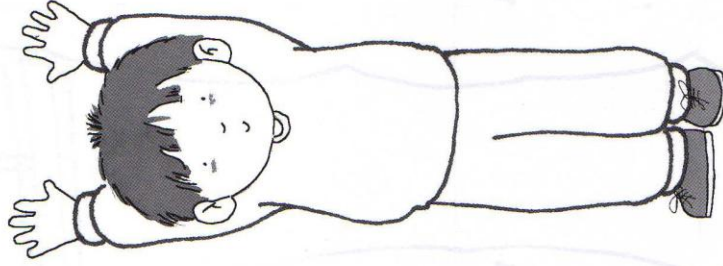
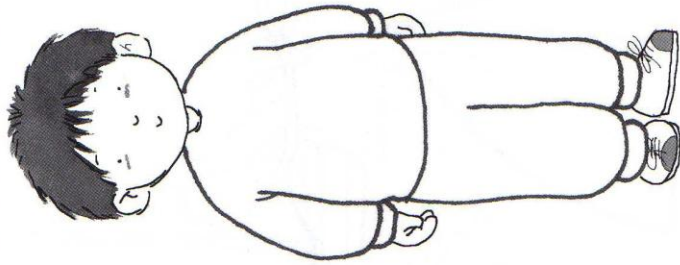
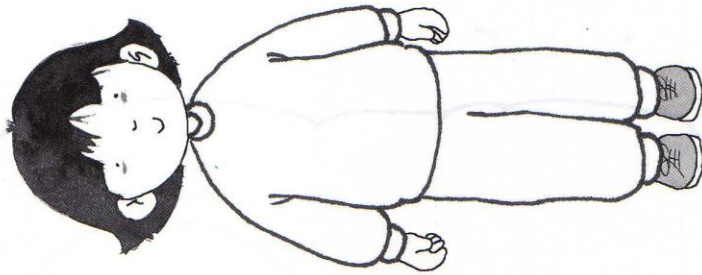
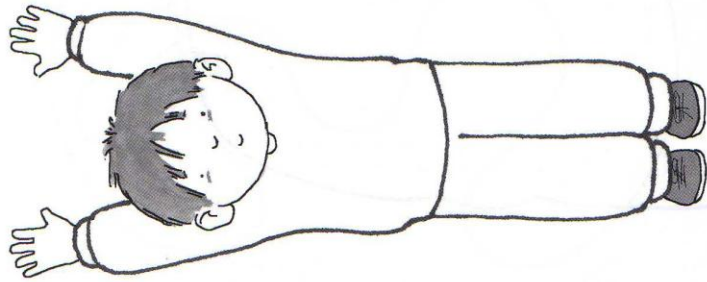

Colorar las camisetas de los niños que tienen los brazos arriba  
y los pantalones de los que tienen los brazos abajo.